



Chorus 49

(single and double leaf)



Timber Acoustic & Fire Rated Doorsets



Rw 48dB
FCBA 404-14-190



EI30 FD30
EITHER SIDE – CSTB RS14-090



3c Stability*



Smoke Seal
S_a Classification
EN 13501-2 - BS EN 1634-3

Door Leaf

- Huet multi-layer acoustic core
- Thickness: 84mm hardwood stiles all round
- High stability leaf due to the inclusion of 4 steel sheets

Ironmongery

- 4 lift-off ball bearing hinges - 190 x 80mm black
- Cut-outs/mortices are available to suit a variety of locks and handles
- Electric striking plate (available on single leaf)

Door Frame

- Hardwood
- Rebated monoblock frame
- Variety of widths
- Extension linings available
- Frame can be lacquered, stained or varnished
- Frame can be wrapped with wood veneer to match door leaf facings

Perimeter Seals

- Intumescent seals factory fitted (within the frame and leaf)
- Combined smoke and acoustic seals fitted within the frame and leaf
- Large thresholds selection

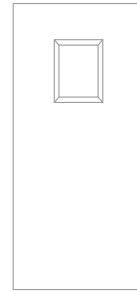

400x300

Choice of Door Facings

- Primed
- Wood veneers
- Laminated
- White paint finish + other colour available by request
- Grooved to a wide choice of standard and bespoke finishes

*Stability of the door leaf is an important factor, particularly in areas of temperature variance between rooms or between rooms and corridors. Any distortion of the door leaf will result in the seals not functioning correctly. With the inclusion of a minimum of 2 steel sheets and other materials, Huet door leaves offer less than 2mm of distortion. The result is a door leaf and seal which continues to perform even with wide temperature differences.



Tel: +33 22 812 0413
Rgd Office: JH INDUSTRIES
30 rue Pauline de Lézardière
85300 Challans FRANCE
www.huet-doors.co.uk



Tel: +27 21 852 1716
W.R Quinan Boulevard, Paardevlei,
Somerset West Western Cape, SOUTH AFRICA
sales@varilux.co.za
www.varilux.co.za

All sizes are in mm

FEBRUARY 2020





Chorus 49

(single and double leaf)



Timber Acoustic & Fire Rated Doorsets

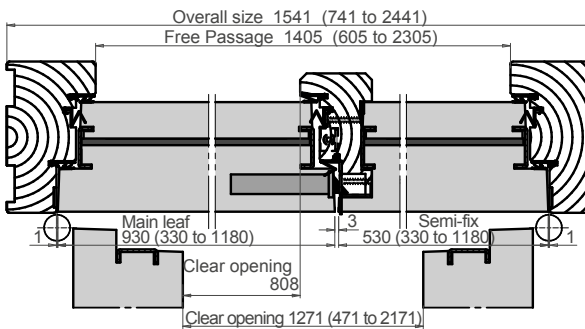
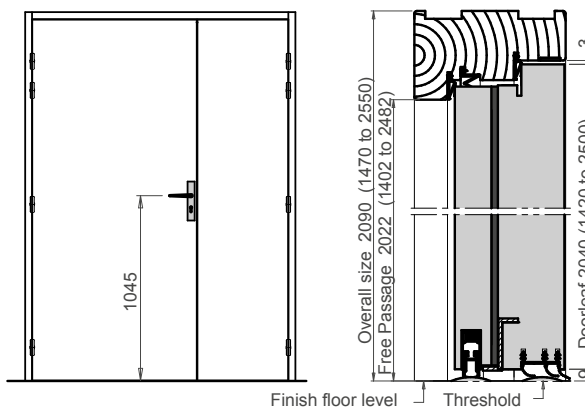
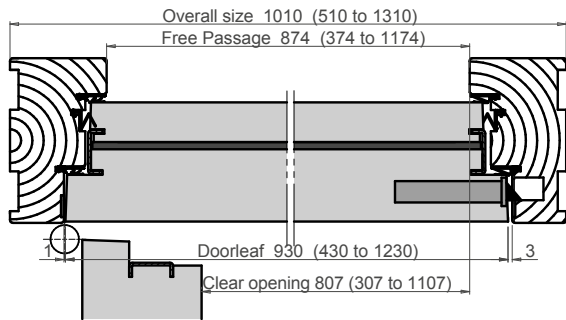
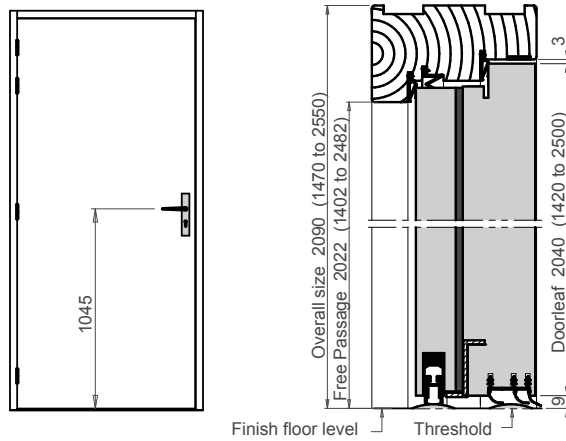

Pyramidal threshold 95x15

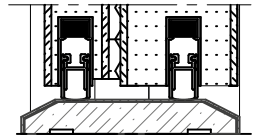

Mechanical drop seals

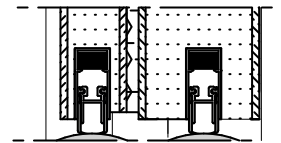

Flat threshold 80x12

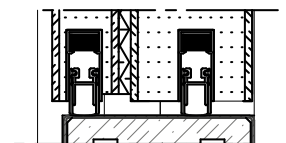

Lip seal

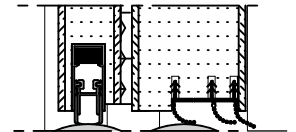

Flat threshold 80x12

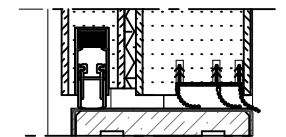

Pyramidal threshold 95x15

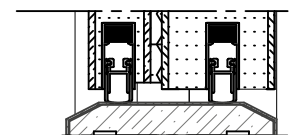

Tel: +33 22 812 0413
Rgd Office: JH INDUSTRIES
30 rue Pauline de Lézardière
85300 Challans FRANCE
www.huet-doors.co.uk



Tel: +27 21 852 1716
W.R Quinan Boulevard, Paardevelei,
Somerset West Western Cape, SOUTH AFRICA
sales@varilux.co.za
www.varilux.co.za

All sizes are in mm

FEBRUARY 2020



©JH INDUSTRIES
Any reproduction, even partial, is forbidden.